

Recticel Insulation Products

(a division of Recticel Ltd)

Enterprise Way
Meir Park
Stoke on Trent
Staffordshire ST3 7UN

Tel: 01782 590470 Fax: 01782 590497
e-mail: technicalservices@recticel.com
website: www.recticelinsulation.co.uk



Agrément Certificate
02/3908
Product Sheet 1

RECTICEL INSULATION

RECTICEL EUROWALL CAVITY

This Agrément Certificate Product Sheet⁽¹⁾ relates to Recticel Eurowall Cavity, a rigid polyisocyanurate board faced on both sides with low emissivity facings. The product is installed during construction and is for use as a partial fill board to reduce the thermal transmittance of cavity walls in new buildings with masonry inner and outer leaves and a minimum residual cavity of 50 mm.

(1) Hereinafter referred to as 'Certificate'.

CERTIFICATION INCLUDES:

- factors relating to compliance with Building Regulations where applicable
- factors relating to additional non-regulatory information where applicable
- independently verified technical specification
- assessment criteria and technical investigations
- design considerations
- installation guidance
- regular surveillance of production
- formal three-yearly review.

KEY FACTORS ASSESSED

Thermal performance — the product has a declared thermal conductivity (λ_D value) of $0.022 \text{ W}\cdot\text{m}^{-1}\cdot\text{K}^{-1}$ and an aged emissivity of 0.05 for the facing (see section 6).

Watertightness — the product will resist water transfer across the cavity of the walls (see section 7).

Condensation — the product will contribute to limiting the risk of condensation (see section 8).

Behaviour in relation to fire — the Certificate holder has not declared a reaction to fire classification to BS EN 13501-1 : 2018 (see section 9).

Durability — the product will have a life equivalent to that of the wall structure in which it is incorporated (see section 12).

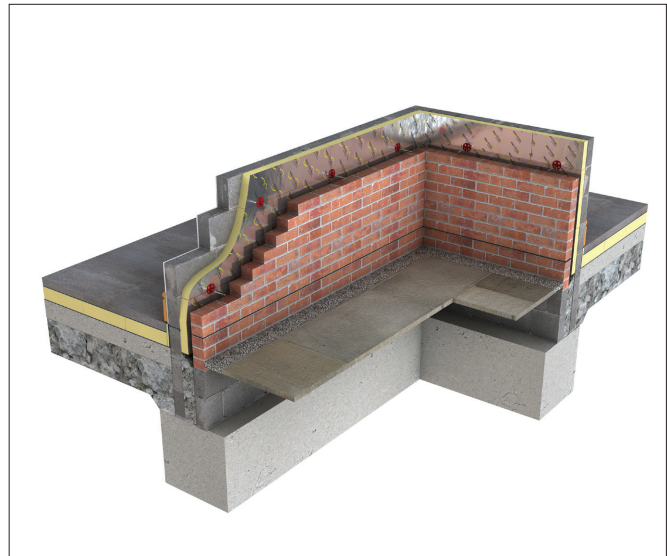

The BBA has awarded this Certificate to the company named above for the product described herein. This product has been assessed by the BBA as being fit for its intended use provided it is installed, used and maintained as set out in this Certificate.

On behalf of the British Board of Agrément

A handwritten signature in black ink, appearing to read 'John Albon'.

John Albon — Head of Approvals
Energy and Ventilation

A handwritten signature in black ink, appearing to read 'Claire Curtis-Thomas'.

Claire Curtis-Thomas
Chief Executive

Date of Second issue: 11 September 2013

Originally certificated on 22 March 2002

Certificate amended on 17 March 2014 to include changes to section 4.

Certificate amended on 4 April 2019 to include Regulation 7(2) for England and associated text.

Certificate amended on 13 January 2020 to include new regulatory guidance for fire in Scotland and Wales.

The BBA is a UKAS accredited certification body – Number 113.

The schedule of the current scope of accreditation for product certification is available in pdf format via the UKAS link on the BBA website at www.bbacerts.co.uk

Readers **MUST** check the validity and latest issue number of this Agrément Certificate by either referring to the BBA website or contacting the BBA directly.

Any photographs are for illustrative purposes only, do not constitute advice and should not be relied upon.

British Board of Agrément

Bucknalls Lane
Watford
Herts WD25 9BA

©2013

tel: 01923 665300
clientservices@bbacerts.co.uk
www.bbacerts.co.uk

Regulations

In the opinion of the BBA, Recticel Eurowall Cavity, if installed, used and maintained in accordance with this Certificate, will meet or contribute to meeting the relevant requirements of the following Building Regulations (the presence of a UK map indicates that the subject is related to the Building Regulations in the region or regions of the UK depicted):



The Building Regulations 2010 (England and Wales) (as amended)

Requirement:	B3(4)	Internal fire spread (structure)
Comment:		The product is restricted by this Requirement. See sections 9.1 to 9.3 and 9.5 of this Certificate.
Requirement:	B4(1)	External fire spread
Comment:		The product is restricted in some cases by this Requirement. See sections 9.1 to 9.3 and 9.5 of this Certificate.
Requirement:	C2(a)	Resistance to moisture
Comment:		The product can contribute to satisfying this Requirement. See section 7.1 of this Certificate.
Requirement:	C2(c)	Resistance to moisture
Comment:		The product can contribute to satisfying this Requirement. See sections 8.1 and 8.3 of this Certificate.
Requirement:	L1(a)(i)	Conservation of fuel and power
Comment:		The product can contribute to satisfying this Requirement. See sections 6.1 and 6.3 of this Certificate.
Regulation:	7(1)	Materials and Workmanship
Comment:		The product is acceptable. See section 12 and the <i>Installation</i> part of this Certificate.
Regulation:	7(2)	Materials and Workmanship
Comment:		The product is restricted by this Regulation. See sections 9.1 and 9.2 of this Certificate.
Regulation:	26	CO₂ emission rates for new buildings
Comment:		The product can contribute to satisfying this Regulation. See sections 6.1 and 6.3 of this Certificate.



The Building (Scotland) Regulations 2004 (as amended)

Regulation:	8(1)	Durability, workmanship and fitness of materials
Comment:		The product is acceptable. See section 12 and the <i>Installation</i> part of this Certificate.
Regulation:	9	Building standards applicable to construction
Standard:	2.6	Spread to neighbouring buildings
Comment:		The product is restricted by this Standard with respect to clauses 2.6.5 ⁽¹⁾ and 2.6.6 ⁽²⁾ . See sections 9.1, 9.4 and 9.5 of this Certificate.
Standard:	3.4	Moisture from the ground
Comment:		The product can contribute to satisfying this Standard, with reference to clauses 3.4.1 ⁽¹⁾ and 3.4.5 ⁽¹⁾⁽²⁾ . See section 7.1 of this Certificate.
Standard:	3.15	Condensation
Comment:		The product can contribute to satisfying this Standard, with reference to clauses 3.15.1 ⁽¹⁾ , 3.15.3 ⁽¹⁾ and 3.15.4 ⁽¹⁾ . See sections 8.2 and 8.3 of this Certificate.
Standard:	6.1(b)	Carbon dioxide emissions
Standard:	6.2	Building insulation envelope
Comment:		The product can contribute to satisfying this Standard, with reference to with clauses, or parts of clauses, 6.1.1 ⁽¹⁾ , 6.1.2 ⁽¹⁾⁽²⁾ , 6.1.6 ⁽¹⁾ , 6.2.1 ⁽¹⁾⁽²⁾ , 6.2.3 ⁽¹⁾ , 6.2.9 ⁽¹⁾ , 6.2.11 ⁽¹⁾⁽²⁾ and 6.2.12 ⁽²⁾ . See sections 6.1 and 6.3 of this Certificate.
Standard:	7.1(a)(b)	Statement of sustainability
Comment:		The product can contribute to satisfying the relevant requirements of Regulation 9, Standards 1 to 6, and, therefore, will contribute to a construction meeting a bronze level of sustainability as defined in this Standard. See section 6.1 of this Certificate. In addition, the product can contribute to a construction meeting a higher level of sustainability as defined in this Standard, with reference to clauses 7.1.4 ⁽¹⁾⁽²⁾ [Aspects 1 ⁽¹⁾⁽²⁾ and 2 ⁽¹⁾], 7.1.6 ⁽¹⁾⁽²⁾ [Aspects 1 ⁽¹⁾⁽²⁾ and 2 ⁽¹⁾] and 7.1.7 ⁽¹⁾⁽²⁾ [Aspect 1 ⁽¹⁾⁽²⁾]. See section 6.1 of this Certificate.
Regulation:	12	Building standards applicable to conversions
Comment:		All comments given for this product under Regulation 9, Standards 1 to 6, also apply to this Regulation, with reference to clause 0.12.1 ⁽¹⁾ and Schedule 6 ⁽¹⁾ . (1) Technical Handbook (Domestic). (2) Technical Handbook (Non-Domestic).



The Building Regulations (Northern Ireland) 2012 (as amended)

Regulation:	23	Fitness of materials and workmanship
Comment:		The product is acceptable. See section 12 and the <i>Installation</i> part of this Certificate.
Regulation:	28(a)	Resistance to moisture and weather
Comment:		The product can contribute to satisfying this Regulation. See section 7.1 of this Certificate.
Regulation:	29	Condensation
Comment:		The product can contribute to satisfying this Regulation. See section 8.3 of this Certificate.

Regulation:	35(4)	Internal fire spread – structure
Comment:		The product is restricted by this Regulation. See sections 9.1, 9.3 and 9.5 of this Certificate.
Regulation:	36(a)	External fire spread
Comment:		The product is restricted by this Regulation. See sections 9.1, 9.3 and 9.5 of this Certificate.
Regulation:	39(a)(i)	Conservation measures
Regulation:	40(2)	Target carbon dioxide emission rate
Comment:		The product can contribute to satisfying these Regulations. See sections 6.1 and 6.3 of this Certificate.

Construction (Design and Management) Regulations 2007

Construction (Design and Management) Regulations (Northern Ireland) 2007

Information in this Certificate may assist the client, CDM co-ordinator, designer and contractors to address their obligations under these Regulations.

See section: 3 *Delivery and site handling* (3.3) of this Certificate.

Additional Information

NHBC Standards 2013

NHBC accepts the use of Recticel Eurowall Cavity, provided it is installed and used in accordance with this Certificate, in relation to *NHBC Standards*, Chapter 6.1 *External masonry walls*.

CE marking

The Certificate holder has taken the responsibility of CE marking the product in accordance with harmonised European Standard BS EN 13165 : 2012. An asterisk (*) appearing in this Certificate indicates that data shown is given in the manufacturer's Declaration of Performance.

Technical Specification

1 Description

Recticel Eurowall Cavity consists of a core of rigid polyisocyanurate board faced on either side by an aluminium foil/kraft paper laminate. The nominal characteristics are given in Table 1.

Table 1 Nominal characteristics⁽¹⁾

Characteristic	Value
Length* (mm)	1200
Width* (mm)	450
Thickness* (mm)	25-100
Nominal density (kg·m ⁻³)	30
Edge profile	square edge

2 Manufacture

2.1 The product is manufactured in accordance with the BS EN 13165 : 2012 and consists of a rigid polyisocyanurate board faced with aluminium/kraft laminate during the process.

2.2 As part of the assessment and ongoing surveillance of product quality, the BBA has:

- agreed with the manufacturer the quality control procedures and product testing to be undertaken
- assessed and agreed the quality control operated over batches of incoming materials
- monitored the production process and verified that it is in accordance with the documented process
- evaluated the process for management of nonconformities
- checked that equipment has been properly tested and calibrated
- undertaken to carry out the above measures on a regular basis through a surveillance process, to verify that the specifications and quality control operated by the manufacturer are being maintained.

2.3 The management system of Recticel Insulation Products has been assessed and registered as meeting the requirements of BS EN ISO 9001 : 2008 by Lloyd's Register Quality Assurance (Certificate 951267).

3 Delivery and site handling

3.1 The product is delivered to site in polythene wrapped packs. The grade, manufacturer's trade name and BBA logo incorporating the Certificate number are printed on every pack.

3.2 The product must be protected from prolonged exposure to sunlight and should be stored either under cover or protected with light-coloured, opaque polythene sheets. Where possible, packs should be stored inside. If stored outside, the product should be raised above ground level out of contact with ground moisture, and must be protected from rain.

3.3 The product must not be exposed to naked flame or other ignition sources. Care must be taken to avoid contact with solvents and with materials containing volatile organic compounds. If damaged, the product should be discarded.

Assessment and Technical Investigations

The following is a summary of the assessment and technical investigations carried out on Recticel Eurowall Cavity.

Design Considerations

4 Use

4.1 Recticel Eurowall Cavity is effective in reducing the U value (thermal transmittance) of new external cavity walls with masonry inner and outer leaves (masonry includes clay and calcium silicate bricks, concrete blocks, natural and reconstituted stone blocks). It is essential that the residual cavity is of a minimum such walls are designed and constructed to incorporate the normal precautions to prevent moisture penetration.

4.2 Buildings subject to the national Building Regulations should be constructed in accordance with the relevant recommendations of:

- BS EN 1996-1-1 : 2005
- BS EN 1996-2 : 2006
- BS EN 1996-3 : 2006
- BS 8000-3 : 2001.

4.3 Other buildings not subject to these Regulations should also be built in accordance with the Standards given in section 4.2.

4.4 Wall ties and fixings and if required any additional twist ties to BS EN 845-1 : 2003 should be used for structural stability in accordance with BS EN 1996-1-1 : 2005, BS EN 1996-2 : 2006 and BS EN 1996-3 : 2006 where the overall cavity width exceeds 75 mm.

4.5 The use of cavity battens or boards is strongly recommended to prevent thermal bridging by mortar droppings.

4.6 As with any other form of cavity wall insulation, where buildings need to comply with *NHBC Standards 2013*, specifiers should observe the requirements of these Standards.

Buildings up to and including 12 metres high

4.7 The minimum residual cavity width to be maintained during construction must be 25 mm. To achieve this requirement, a greater nominal residual cavity width may need to be specified at the design stage to allow for inaccuracies inherent in the building process. The specifier may either:

- design a cavity width by consideration of the dimensional tolerances of the components which make up the wall by reference to the British Standards relating to the bricks, blocks and boards, or use the data from their respective manufacturers. In addition, allowance may need to be made for the quality of available building operatives and the degree of site supervision or control available. The limitations in respect of exposure of the proposed building as set out in Table 2 must also be observed, or
- design a nominal residual cavity width of 50 mm (a residual cavity nominally at least 50 mm wide will be required by the NHBC).

Table 2 Maximum allowable total exposure factors of different constructions

Construction	Maximum allowable exposure factor E ⁽¹⁾
All external masonry walls protected by: rendering (to BS EN 13914-1 : 2005) tile hanging slate hanging timber, plastic or metal weatherboarding or cladding	no restriction
One or more external masonry walls constructed from facing clay brickwork or natural stone, the porosity of which exceeds 20% by volume. Mortar joints must be flush pointed or weatherstruck	100
One or more external masonry walls constructed from calcium silicate bricks, concrete blocks, reconstituted stone or natural stone, the porosity of which is less than 20% by volume, or any material with raked mortar joints	88

(1) To BS 5618 : 1985.

4.8 An external render coat or other suitable finish should be applied in locations where such application would be normal practice and care should be taken to ensure that the residual cavity is not bridged by mortar.

Buildings over 12 metres in height

4.9 The width of the residual clear cavity to be achieved is to be in excess of 50 mm, and the following additional requirements apply:

- from ground level the maximum height of continuous cavity walls must not exceed 12 metres; above 12 metres the maximum height of continuous cavity walls must not exceed 7 metres. In both cases, breaks should be in the form of continuous horizontal cavity trays and weepholes discharging to the outside
- the specifier must take extra care when detailing to ensure that the introduction of the insulation does not affect the weather resistance of the wall. Above average site supervision during the installation of the product
- where, for structural reasons, the cavity width is reduced, eg by the intrusion of ring beams, a minimum residual cavity width of 25 mm must be maintained and extra care must be taken with fixings and weatherproofing, eg the inclusion of cavity trays with weepholes.

5 Practicability of installation

The product is designed to be installed by a competent general builder, or a contractor, experienced with this type of product.

6 Thermal performance

 6.1 Calculations of thermal transmittance (U value) should be carried out in accordance with BS EN ISO 6946 : 2007 and *BRE Report BR 443 : 2006*, using the declared thermal conductivity (λ_D value)* of $0.022 \text{ W}\cdot\text{m}^{-1}\cdot\text{K}^{-1}$ for the insulations and the aged emissivity of the foil-facing is 0.05 to BS EN 15976 : 2011.

6.2 The U value of a completed wall will depend on the selected insulation thickness, number and type of fixings, the insulating value of the substrate masonry and its internal finish. Calculated U values for example constructions are given in Table 3.

U value $\text{W}\cdot\text{m}^{-2}\cdot\text{K}^{-1}$	Thickness of product required (mm)	
	AAC block ($\lambda = 0.12 \text{ W}\cdot\text{m}^{-1}\cdot\text{K}^{-1}$)	$\lambda = 1.13 \text{ W}\cdot\text{m}^{-1}\cdot\text{K}^{-1}$
0.19	75	90
0.26	45	60
0.28	40	55
0.30	35	50
0.35	25	35

(1) Assumes stainless steel fixings ($\lambda = 17 \text{ W}\cdot\text{m}^{-1}\cdot\text{K}^{-1}$) correction $\Delta U_f < 3\%$ of nominal U value and 102 mm thick brick outer leaf and mortar thermal conductivity: $0.88 \text{ W}\cdot\text{m}^{-1}\cdot\text{K}^{-1}$.

(2) Plaster on dabs thermal conductivity: $0.43 \text{ W}\cdot\text{m}^{-1}\cdot\text{K}^{-1}$.

(3) Plasterboard: thermal conductivity: $0.25 \text{ W}\cdot\text{m}^{-1}\cdot\text{K}^{-1}$.

(4) Percentage of overprint on the foil is less than 2%.

 6.3 The product can maintain, or contribute to maintaining, the continuity of thermal insulation at junctions between elements and openings. For Accredited Construction Details the corresponding ψ -values (psi) in *BRE Information Paper IP 1/06*, Table 3, may be used in carbon emission calculations in Scotland and Northern Ireland. Detailed guidance for other junctions and on limiting heat loss by air infiltration can be found in:

England and Wales — Approved Documents to Part L and for new thermal elements to existing buildings, Accredited Construction Details (version 1.0). See also SAP 2009 Appendix K and the *iSBEM User Manual* for new-build

Scotland — Accredited Construction Details (Scotland)

Northern Ireland — Accredited Construction Details (version 1.0).

6.4 The Certificate holder has at least one member of staff who has been deemed competent by the BBA under the BBA/TIMSA Scheme for Calculation Competency (U value and Condensation Risk Analysis). Competent persons should be contacted for accurate, quality-assured U value and condensation risk analysis. The Certificate of Competency can be found on the BBA website (<http://www.bbacerts.co.uk>) as Certificate CS/1003.

7 Watertightness

 7.1 When the product is used in situations where it bridges the damp-proof course (dpc) in walls, dampness from the ground will not pass through to the inner leaf provided the wall is detailed in accordance with the requirements and provisions of the national Building Regulations:

England and Wales — Approved Document C, Section 5

Scotland — Mandatory Standard 3.4, clauses 3.4.1⁽¹⁾ and 3.4.5^{(1)|(2)}

(1) Technical Handbook (Domestic).

(2) Technical Handbook (Non-Domestic).

Northern Ireland — Technical Booklet C, Section 6

7.2 Constructions incorporating the product and built in accordance with the Standards listed in section 4.2, will resist the transfer of precipitation to the inner leaf and satisfy the national Building Regulations:

England and Wales — Requirement C2

Scotland — Mandatory Standard 3.10, clause 3.10.5^{(1)|(2)}

(1) Technical Handbook (Domestic).

(2) Technical Handbook (Non-Domestic).

Northern Ireland — Technical Booklet C, Section 6.

7.3 In all situations it is particularly important to ensure during installation that:

- wall ties and fixings are installed correctly and are thoroughly clean
- excess mortar is cleaned from the cavity face of the leading leaf and any debris removed from the cavity
- mortar droppings are cleaned from the exposed edges of installed boards
- boards are properly installed and butt jointed
- installation is carried out to the highest level on each wall or the top edge of the insulation is protected by a cavity tray
- at lintel level, a cavity tray, stopends and weep holes, must be provided.

8 Condensation

Surface condensation

 8.1 Walls will limit the risk of surface condensation adequately when the thermal transmittance (U value) does not exceed $0.7 \text{ W}\cdot\text{m}^{-2}\cdot\text{K}^{-1}$ at any point, and the junctions with floors, roofs and openings are designed in accordance with the TSO publication *Limiting thermal bridging and air leakage : Robust construction details for dwellings and similar buildings* or *BRE Information Paper IP 1/06*.

 8.2 Walls will adequately limit the risk of surface condensation when the thermal transmittance (U value) does not exceed $1.2 \text{ W}\cdot\text{m}^{-2}\cdot\text{K}^{-1}$ at any point. Guidance may be obtained from BS 5250 : 2011, Annex G, and *BRE Report BR 262 : 2002*.

Interstitial condensation

 8.3 Walls will limit the risk of interstitial condensation adequately when they are designed and constructed in accordance with BS 5250 : 2011 (Annexes D and G).

8.4 The core of the product has a water vapour resistivity of $300 \text{ MN}\cdot\text{s}\cdot\text{g}^{-1}\cdot\text{m}^{-1}$, and a water vapour resistance of $4000 \text{ MN}\cdot\text{s}\cdot\text{g}^{-1}$ for the facing.

9 Behaviour in relation to fire

 9.1 The Certificate holder has not declared a reaction to fire classification to BS EN 13501-1 : 2018. The product is not classified as non-combustible or of limited combustibility.

 9.2 In England and Wales, the product should not be used on buildings with a storey 18 m or more above ground level and which contain: one or more dwellings, an institution, a room for residential purposes (excluding any room in a hostel, hotel or boarding house), student accommodation, care homes, sheltered housing, hospitals or dormitories in boarding schools.

 9.3 In England, Wales and Northern Ireland, the product is unrestricted in terms of proximity to a boundary and, for constructions comprising two leaves of brick or concrete each at least 75 mm thick and with cavities closed around openings, is unrestricted in terms of height (with the exception of constructions described in section 9.2 of this Certificate).

 9.4 In Scotland, the product is not classified as 'non-combustible' but may be used without height restriction in a wall on, or less than 1 m from, a relevant boundary, provided it is installed in a cavity that is between two leaves of masonry at least 75 mm thick and which has a cavity barrier around all openings in the wall and at the top of the wall head.

 9.5 For constructions not covered by sections 9.3 or 9.4, the use of the product is restricted to buildings with no floor more than 18 m (11 m in Scotland) above the ground, and cavity barriers must be provided to comply with the relevant provisions of the national Building Regulations.

9.6 Designers should refer to the relevant national Building Regulations and guidance for detailed conditions of use, particularly in respect of requirements for substrate fire performance, cavity closers and barriers, fire stopping of service penetrations and combustibility limitations for other materials and components used in the overall wall construction.

10 Proximity of flues and appliances

When installing the product in close proximity to certain flue pipes and/or heat-producing appliances, the following provisions to the national Building Regulations are acceptable:

England and Wales — Approved Document J, sections 1 to 4

Scotland — Mandatory Standard 3.19, clauses 3.19.1⁽¹⁾⁽²⁾ to 3.19.9⁽¹⁾⁽²⁾

(1) Technical Handbook (Domestic).

(2) Technical Handbook (Non-Domestic).

11 Maintenance

As the product is confined within the wall cavity and it has suitable durability (see section 12), maintenance is not required.

12 Durability



The product is dimensionally stable, rot-proof and durable, and will remain effective as an insulant for the life of the building.

Installation

13 General

It is recommended that the inner leaf be constructed ahead of the outer leaf, as boards fastened to the cavity face of the inner leaf give a slightly enhanced thermal performance. It is essential that the spacing of the wall ties/clips allows the long edge of each board to be secured at a minimum of two points.

14 Procedure

14.1 A section of the inner leaf is built with the first row of wall ties, at approximately 600 mm horizontal spacing, where the insulation is to begin. The wall ties should not be placed directly on the dpc. The first run of boards should commence below the dpc level to provide some edge insulation for the floor (see Figure 1).

Figure 1 Typical installation

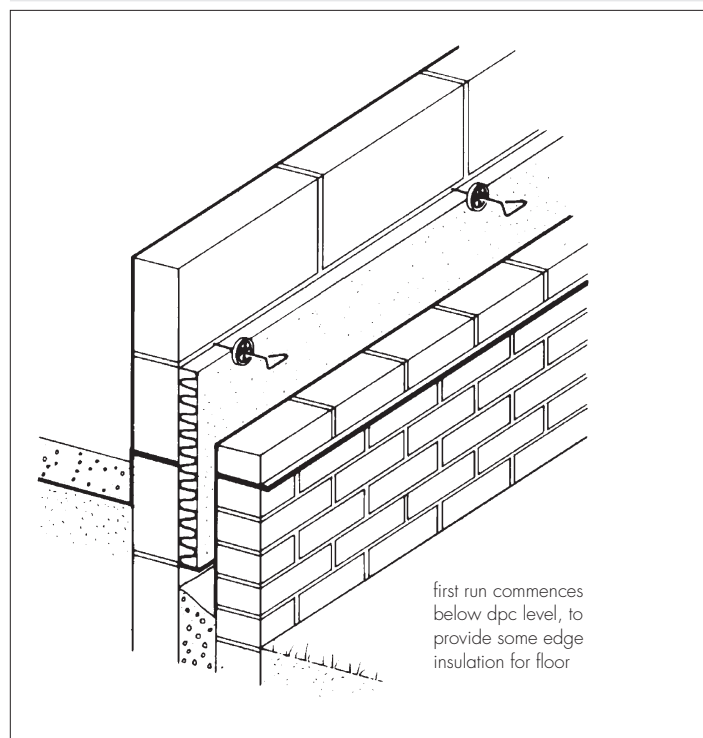

14.2 The leading leaf is built up to the required height, with wall ties placed at a vertical height of 450 mm ensuring the drip of the tie is located halfway across the residual cavity width. Excess mortar is cleaned from the cavity face of the leading leaf, and the boards are placed on the wall ties, behind the retaining clips, to form a closely butt-jointed run.

14.3 The second row of wall ties is fitted to retain the tops of the boards. It is essential that all wall ties slope downwards towards the outer leaf (see Figure 2) and are placed at centres not exceeding 900 mm to ensure that each board is secured at a minimum of three points. It is also important that the first row of insulation should not be in contact with the ground.

Figure 2 Installation of wall ties

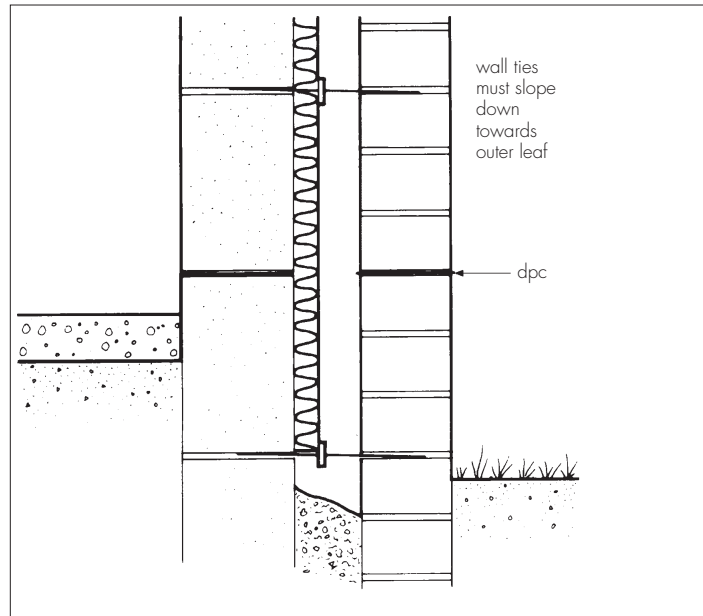

14.4 Additional wall ties may be required to satisfy the structural requirements of BS EN 845-1 : 2003, BS EN 1996-1-1 : 2005, BS EN 1996-2 : 2006 and BS EN 1996-3 : 2006 to ensure adequate retention of boards or cut pieces.

14.5 The other leaf is built up to the level of the top of the boards.

14.6 All boards should be butted with vertical joints staggered. Insulation boards and wall ties should be staggered as construction proceeds and carried up to the highest level of wall, except where protected by a cavity tray.

Mortar droppings

14.7 After each section of the leading leaf is built, excess mortar should be removed from the cavity face and mortar droppings cleaned from exposed edges of the installed board, before installation of the next run of boards. Use of a cavity board or a cavity batten will protect the installed board edges and help to keep the cavity clean as the following leaf is built (see Figures 3 and 4).

Figure 3 Use of cavity board

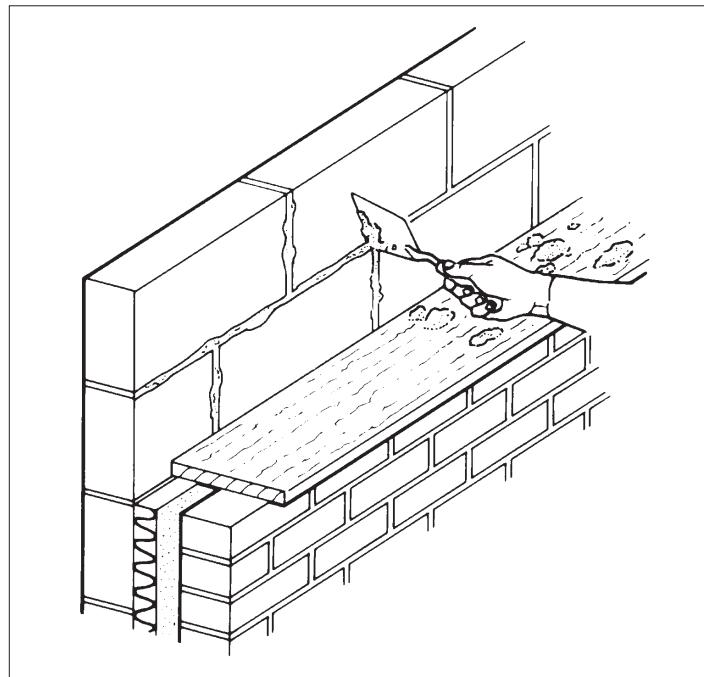
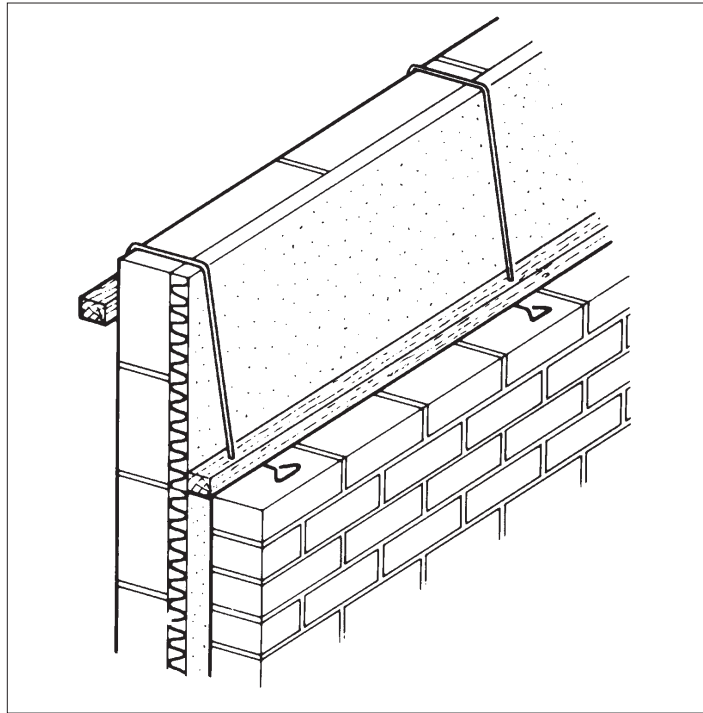

Figure 4 Use of cavity batten



Wall openings

14.8 Where openings such as doors and windows are in close proximity, it is recommended that a continuous lintel or cavity tray is used. Individual lintels or cavity trays should have stopends and be adequately drained.

Cut pieces

14.9 Boards can be cut, using a sharp knife or fine-toothed saw, to fit openings, eg around windows, doors and air bricks. It is essential that cut pieces of board completely fill the spaces for which they are intended and are adequately secured.

Protection

14.10 All building involving the product, particularly interrupted work, must conform to BS EN 1996-2 : 2006, Sections 3.2 *Acceptance, handling and storage of materials* and 3.6 *Curing and protective procedures during execution*.

Technical Investigations

15 Investigations

An examination was made of test data relating to:

- water vapour resistance
- density
- thermal conductivity
- closed cell count
- compressive strength at 10% strain
- water absorption
- dimensional accuracy
- dimensional stability with temperature and humidity
- cross-breaking strength
- condensation risk.

Bibliography

- BS 5250 : 2011 *Code of practice for control of condensation in buildings*
- BS 5618 : 1985 *Code of practice for thermal insulation of cavity walls (with masonry or concrete inner and outer leaves) by filling with urea-formaldehyde (UF) foam systems*
- BS 8000-3 : 2001 *Workmanship on building sites — Code of practice for masonry*
- BS EN 845-1 : 2003 *Specification for ancillary components for masonry — Ties, tension straps, hangers and brackets*
- BS EN 1996-1-1 : 2005 *Eurocode 6 : Design of masonry structures — General rules for reinforced and unreinforced masonry structures*
- BS EN 1996-2 : 2006 *Eurocode 6 : Design of masonry structures — Design considerations, selection of materials and execution of masonry*
- BS EN 1996-3 : 2006 *Eurocode 6 : Design of masonry structures : Simplified calculation methods for unreinforced masonry structures*
- BS EN 13165 : 2012 *Thermal insulation products for buildings — Factory made rigid polyurethane foam (PU) products — Specification*
- BS EN 13501-1 : 2018 *Fire classification of construction products and building elements — Classification using data from reaction to fire tests*
- BS EN 13914-1 : 2005 *Design, preparation and application of external rendering and internal plastering — External rendering*
- BS EN 15976 : 2011 *Flexible sheets for waterproofing — Determination of emissivity*
- BS EN ISO 6946 : 2007 *Building components and building elements — Thermal resistance and thermal transmittance — Calculation method*
- BS EN ISO 9001 : 2008 *Quality management systems — Requirements*
- BRE Information Paper IP 1/06 *Assessing the effects of thermal bridging at junctions and around openings*
- BRE Report (BR 262 : 2002) *Thermal insulation: avoiding risks*
- BRE Report (BR 443 : 2006) *Conventions for U-value calculations*

16 Conditions

16.1 This Certificate:

- relates only to the product/system that is named and described on the front page
- is issued only to the company, firm, organisation or person named on the front page — no other company, firm, organisation or person may hold or claim that this Certificate has been issued to them
- is valid only within the UK
- has to be read, considered and used as a whole document — it may be misleading and will be incomplete to be selective
- is copyright of the BBA
- is subject to English Law.

16.2 Publications, documents, specifications, legislation, regulations, standards and the like referenced in this Certificate are those that were current and/or deemed relevant by the BBA at the date of issue or reissue of this Certificate.

16.3 This Certificate will remain valid for an unlimited period provided that the product/system and its manufacture and/or fabrication, including all related and relevant parts and processes thereof:

- are maintained at or above the levels which have been assessed and found to be satisfactory by the BBA
- continue to be checked as and when deemed appropriate by the BBA under arrangements that it will determine
- are reviewed by the BBA as and when it considers appropriate.

16.4 The BBA has used due skill, care and diligence in preparing this Certificate, but no warranty is provided.

16.5 In issuing this Certificate, the BBA is not responsible and is excluded from any liability to any company, firm, organisation or person, for any matters arising directly or indirectly from:

- the presence or absence of any patent, intellectual property or similar rights subsisting in the product/system or any other product/system
- the right of the Certificate holder to manufacture, supply, install, maintain or market the product/system
- actual installations of the product/system, including their nature, design, methods, performance, workmanship and maintenance
- any works and constructions in which the product/system is installed, including their nature, design, methods, performance, workmanship and maintenance
- any loss or damage, including personal injury, howsoever caused by the product/system, including its manufacture, supply, installation, use, maintenance and removal
- any claims by the manufacturer relating to CE marking.

16.6 Any information relating to the manufacture, supply, installation, use, maintenance and removal of this product/system which is contained or referred to in this Certificate is the minimum required to be met when the product/system is manufactured, supplied, installed, used, maintained and removed. It does not purport in any way to restate the requirements of the Health and Safety at Work etc. Act 1974, or of any other statutory, common law or other duty which may exist at the date of issue or reissue of this Certificate; nor is conformity with such information to be taken as satisfying the requirements of the 1974 Act or of any statutory, common law or other duty of care.