

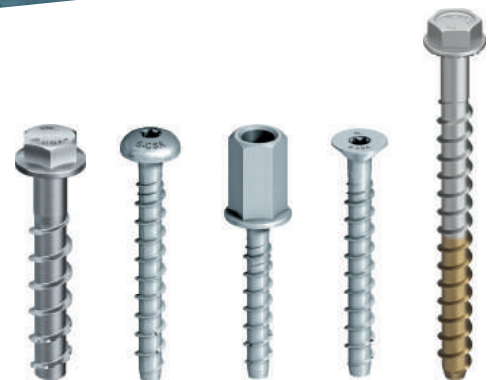

ETA Approved concrete screws

High performance screw anchors for
cracked and non-cracked concrete



Next generation concrete screws

EJOT JC2 and JC6-KB

High performance products with EJOT® technical support

High performing additions to the EJOT range of carbon steel concrete screws now extend the scope for installers to easily achieve a safe and reliable attachment for metal fixtures as well as other hard base materials.

Reflecting continued diversification, these developments allow our JC2 self-tapping concrete screws to be used in an increased range of applications, from façade scaffolding, handrails to battens, cable racks and formwork, warehouse racking and conveyor systems.

In addition to the core product range of galvanised or zinc alloy coated carbon steel concrete screws, EJOT in the UK is introducing an ETA-approved fastener with enhanced corrosion resistance. The JC6-KB is a bi-metallic concrete screw manufactured in A4 316 stainless steel with hardened carbon steel lead threads making it suitable for outdoor option 1 concrete applications and approved for environmental classifications ranging from C1 up to C4, in accordance with BS EN 12944.

Call 01977 687040

info@ejot.co.uk



EJOT UK is a manufacturing member of the CFA.
www.the-cfa.co.uk



ZAG - National Building and Civil Engineering Institute, Slovenia
Deutsches Institut für Bautechnik (DIBt)

Contents

Concrete screws at a glance



PRODUCT RANGE

Product outline	Page 4
Benefits and approvals	Page 5

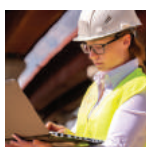

OVERVIEW

Overview details	Page 6
Approvals / certifications / applications	Page 7
Additional information	Page 7

Technical data in detail



SPECIFICATIONS

Quick reference guide	Page 8
Static and quasi-static loads	Page 9
Basic loading data	Page 12
Setting instructions	Page 13
Fire resistance	Page 14
Material and dimensions	Page 15



INSTALLATION INSTRUCTIONS

Installation equipment	Page 16
Installation parameters	Page 17



TOOLS AND ACCESSORIES

Drills and drilling systems	Page 18
Cleaning	Page 18
Driver and wrench	Page 18
Sockets and adaptor	Page 18

Solutions-driven concrete screws for performance-driven installers



EJOT's second-generation range of concrete screws has been updated to provide vastly upgraded performance values and an unrivalled range of application-specific solutions.

Manufactured in carbon steel, variants in the range provide a coating option of zinc or zinc alloy, enhancing a thread geometry that is engineered to provide a safe, secure fix and ease of installation. That means peace of mind and valuable time-savings on site.

Second generation JC2 concrete screws

Option One approval for cracked / non-cracked concrete

- Completely updated screw thread
- Larger thread diameter ensures better grip
- New thread geometry at the point enables easy installation
- Two anchorage depths to offer greater flexibility
- Improved ETA with higher load-carrying

Performance benefits at a glance

- Self-tapping, high-performance screws
- Approved for through-fix installations
- Simple and quick installation
- Small spacings and edge distances
- Minimal expansion forces
- Expanded range of head styles for application-specific solutions

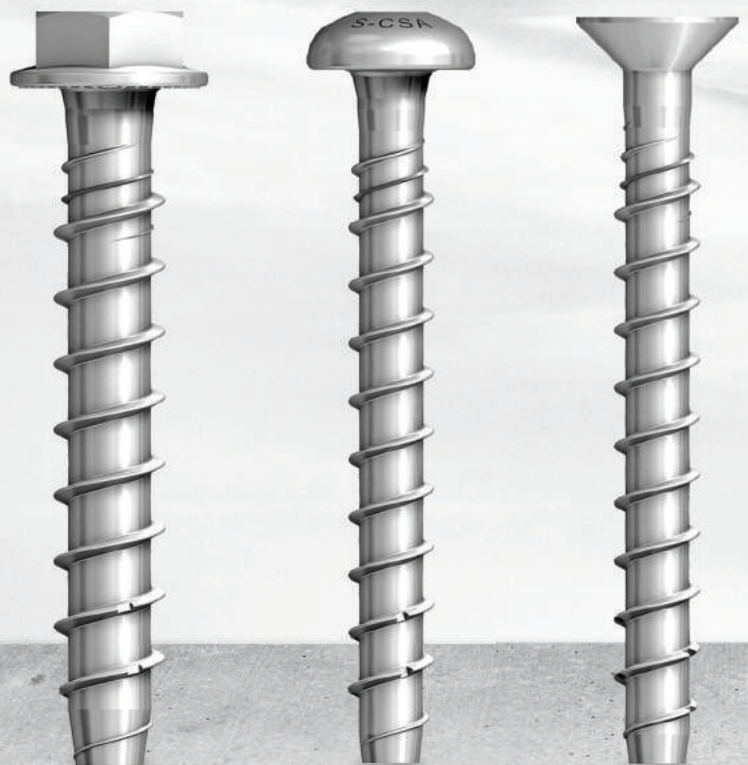

JC2-KB

JC2-FR

JC2-ST



See Option 1 classification
Pages 6 and 7

A4 Stainless steel

JC6-KB is EJOT UK's new bi-metallic, hex-head concrete screw available from 6mm up to 12mm variants. Engineered from corrosion-resistant A4 grade austenitic stainless steel, its gold marking highlights uniquely welded hardened carbon steel lead threads - greatly enhancing installation and environmental performance.

JC6-KB A4 stainless steel concrete screws

Option One approval for cracked / non-cracked concrete

Performance benefits at a glance

- Hardened carbon steel lead threads
- Gold mark bi-met indicator
- Superior corrosion resistance
- Environmental classifications C1 up to C4
- Simple and quick installation
- Anti back-out serrations for extra fixture grip
- Small spacings and edge distances
- Minimal expansion forces

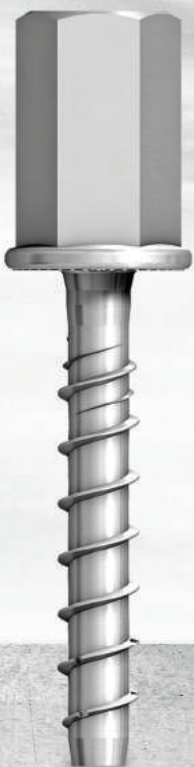

JC2-IT

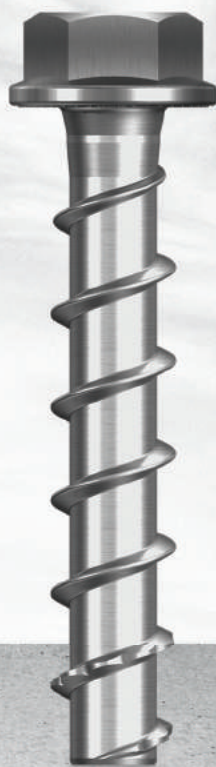

JC2-KB
PLUS



See Option 1 classification
Pages 6 and 7

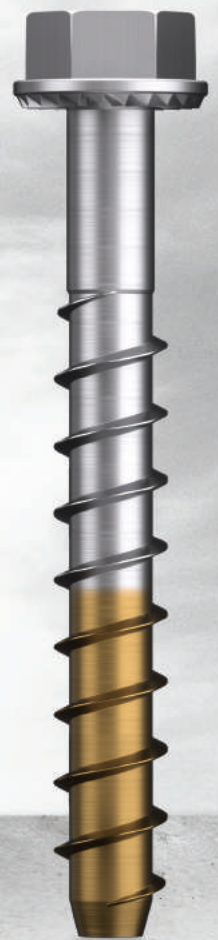

JC6-KB

Call 01977 687040
www.ejot.co.uk/throughbolts

Concrete screws at a glance



Material	Galvanised or zinc alloy coated carbon steel				A4 stainless steel	
Applications	Facade scaffolds, temporary fastening, cable racks, hand rails, battens			Pipe brackets, profile rails	Facade scaffolds, temporary fastening, cable racks, hand rails, battens, formworks	
Drive	 SW13 TX30	 TX30	 TX30	 SW13	 SW13 SW15 SW21 SW24	 SW10 SW13 SW17 SW19
Cracked concrete ETAG-001-1* <small>*Note: ETAG-001-1 has been replaced by EAD 330232-00-0601</small>	Ø 6 - 14mm				Ø 8 - 12mm	
Cracked concrete ETAG-001-6** <small>**Note: ETAG-001-6 has been replaced by EAD 330747-00-0601</small>	Ø 6mm			-	Ø 6 - 8mm	
Non-cracked concrete	Ø 6 - 14mm				Ø 6 - 12mm	
Certifications	 ETA-17/0835 Option 1	 ETA-18/0221 Option 1 (Part 6)		 ETA-21/0020 Option 1	 ETA-21/0352 Opt 1 ETA-21/0351 Opt 1 (Part 6)	
Fire resistance	 F-resistant R120					
Mode of action	Undercut					
Type of load	Static					
Recommended tensile loads	1.4 - 4.5kN			3.1 - 14.3kN		2.4 - 9.9kN
Recommended shear loads	3.1 - 5.6kN			10.9 - 37.1kN		4.6 - 21.6kN

Lengths, material and fixture guide



JC2-KB	Size	t _{fix}	ETA
6	6x35 SW13	1	•
	6x45 SW13	5/10	•
	6x50 SW13	10/15	•
	6x60 SW13	5/20	••
	6x70 SW13	15/30	••
	6x80 SW13	25/40	••
	6x100 SW13	45/60	••
	6x120 SW13*	65/80	••
	6x140 SW13	85/100	••

Order Example: JC2-KB-6 x 80 SW13

Zinc plated or zinc alloy coating

*Zinc plated only



JC2-FR	Size	t _{fix}	ETA
6	6x35 (L)	1	•**
	6x45	5	•
	6x45 (L)	5	•
	6x60	5/20	••

Order Example: JC2-FR-6 x 45 (L)

Zinc plated, L = Low pan head



JC2-ST	Size	t _{fix}	ETA
6	6x45*	5/10	•
	6x50*	10/15	•
	6x60	5/20	••
	6x80	25/40	••
	6x100	45/60	••
	6x120*	65/80	••

Order Example: JC2-ST-6 x 80

Zinc plated or zinc alloy coating

*Zinc plated only



JC2-IT	Size	ETA
6	6x35 M8/M10x30	•(P)
	6x45 M8/M10x30	•
	6x60 M8/M10x30	••

Order Example: JC2-IT-6 x 45 M8

Zinc plated



JC2-KB Plus	Size	t _{fix}	ETA
8	8x55	5	•
	8x70	5/20	•
	8x80	15/30	•
	8x90	25/40	•
	8x100	35/50	•
	8x120	55/70	•
	8x140	75/90	•
	8x160	95/110	•
10	10x60	5	•
	10x70	15	•
	10x80	25	•
	10x90	5/35	•
	10x100	15/45	•
	10x120	35/65	•
14	10x140	55/85	•
	10x160	75/105	•
	14x75 SW21	10	•
	14x100 SW21	35	•
	14x130 SW21	15/65	•
	14x150 SW21	35/85	•
	14x80 SW24*	15	•
14x110 SW24*	45	•	
14x130 SW24*	15/65	•	

Order Example: JC2-KB Plus 10 x 90

Zinc plated or zinc alloy coating

*Zinc plated only









JC6-KB	Size	t _{fix}	ETA
6	6 x 85/15 SW10	15	•
8	8 x 67/15 SW13	15	••
	8 x 87/35 SW13	35	••
10	10 x 115/15 SW17	15	•
	10 x 125/25 SW17	25	•
	10 x 135/35 SW17	35	•
	10 x 150/50 SW17	50	•
12	12 x 135/15 SW19	15	•
	12 x 150/30 SW19	30	•

Order Example: JC6-KB-10 x 115/15 SW17

A4 stainless steel

• Option 1 Part 6 | • Option 1 | • Part 6 | (P) Pending

Approvals / Certifications / Applications

Description of document		Authority/ Laboratory	ID	Additional info
European Technical Assessment		ZAG -National Building and Civil Engineering Institute, Slovenia	ETA-17/0835 (JC2 6, 8, 10)	EAD 330232-00-0601 Option 1
European Technical Assessment		ZAG -National Building and Civil Engineering Institute, Slovenia	ETA-18/0221 (JC2 6)	Concrete screw of size 6 for multiple use in non-structural applications EAD 330747-00-0601 (Part 6)
European Technical Assessment		ZAG -National Building and Civil Engineering Institute, Slovenia	ETA-21/0020 (JC2 Plus 8, 10, 14)	EAD 330232-00-0601 Option 1
European Technical Assessment		Deutsches Institut für Bautechnik (DIBt)	ETA-21/0351 ETA-21/0352 (JC6-KB)	EAD 330747-00-0601 Option 1 (Part 6) EAD 330232-00-0601 Option 1
Fire Resistance		ZAG -National Building and Civil Engineering Institute, Slovenia Deutsches Institut für Bautechnik (DIBt)	ETA-17/0835 ETA-18/0221 ETA-21/0020 ETA 21/0351 ETA 21/0352	
EJOT Anchor Fix calculation software*		EJOT Software		Free download: www.ejot.co.uk/ software-anchorfix

*Anchor fix does not apply to JC6-KB

Additional information

- Load figures include the partial safety factors as per approvals and a partial safety factor on the action of $\gamma_F = 1.4$. Load figures apply for a rebar spacing $s \geq 150\text{mm}$ or alternatively for a rebar spacing $s \geq 100\text{mm}$ in combination with a rebar diameter of $d_s \leq 10\text{mm}$.
- If spacings or edge distances become smaller than the characteristic figures ($s_{cr,N} / c_{cr,N}$) a calculation as per EOTA TR 055 needs to be carried out. For more details, see ETA-17/0835, ETA-18/0221 and ETA-21/0020 for JC2 products. For JC6-KB products please refer to ETA 21/0351 and ETA 21/0352.
- Concrete is considered non-cracked when the value of tension within the concrete is $\sigma_L + \sigma_R \leq 0$. In the absence of detailed verification $\sigma_R = 3 \text{ N/mm}^2$ can be assumed (σ_L equals the tension within the concrete as a result of external loads, forces on anchor included; σ_R equals the tension coming from shrinkage or creep of the concrete, as well as displacements of supports or temperature variations).
- Shear load figures apply for an anchor without influence of a concrete edge. For shear loads close to an edge ($c \leq 10 \times h_{ef}$), concrete edge failure has to be checked as per EOTA TR 055 or EN 1992-4.

Static and quasi-static loads

Characteristic resistances: JC2 range

			JC2 6: KB / FR / IT / ST			JC2-KB Plus 8		JC2-KB Plus 10		JC2-KB Plus 14	
			PART 6**	PART 6	OPTION 1	OPTION 1	OPTION 1	OPTION 1	OPTION 1	OPTION 1	OPTION 1
Effective anchorage depth	h_{ef}	mm	27.6	31.9	42.5	39.2	51.9	42.5	68.0	49.3	91.8
Nominal anchorage depth	h_{nom}	mm	35	40	55	50	65	55	85	65	115
Non-cracked concrete											
Tensile	N_{Rk}	kN	NA	3.0	9.5	12.1	18.4	13.6	27.6	15.0	42.0
Shear	V_{Rk}	kN	NA	6.5	9.8*	19.1*	21.5*	31.8*	35.2*	61.1*	64.9*
Cracked concrete											
Tensile	N_{Rk}	kN	NA	3.0	4.5	6.5	12.0	7.5	19.0	8.5	30.0
Shear	V_{Rk}	kN	NA	6.5	9.5	19.1*	21.5*	28.6	35.2*	39.3	64.9*

*Failure mode = steel; **Pending

Characteristic resistances: JC6-KB range

			JC6 KB 6 A4	JC6 KB 8 A4	JC6 KB 10 A4	JC6 KB 12 A4
			PART 6	PART 6	OPTION 1	OPTION 1
Effective anchorage depth	h_{ef}	mm	43.1	22.2	58.7	75.6
Nominal anchorage depth	h_{nom}	mm	70.0	52.0	100.0	120.0
Non-cracked concrete						
Tensile	N_{Rk}	kN	5.0	2.0	16.0	25.0
Shear	V_{Rk}	kN	9.0*	5.1	22.1	39.0*
Cracked concrete						
Tensile	N_{Rk}	kN	5.0	2.0	7.0	12.0
Shear	V_{Rk}	kN	9.7	3.6	15.5	45.3

*Failure mode = steel

The data within these tables are based on:

Concrete C20/25, $f_{ck,cube} = 25N/mm^2$

Installation has been done correctly

No influence of edge distances and spacings

Minimum base material thickness is met

Static and quasi-static loads

Design resistances: JC2 range

			JC2 6: KB / FR / IT / ST			JC2 Plus 8		JC2 Plus 10		JC2 Plus 14	
			PART 6**	PART 6	OPTION 1	OPTION 1	OPTION 1	OPTION 1	OPTION 1	OPTION 1	OPTION 1
Effective anchorage depth	h_{ef}	mm	27.6	31.9	42.5	39.2	51.9	42.5	68.0	49.3	91.8
Nominal anchorage depth	h_{nom}	mm	35	40	55	50	65	55	85	65	115
Non-cracked concrete											
Tensile	N_{Rd}	kN	NA	2.0	6.3	8.0	12.3	9.1	18.4	100	28.0
Shear	V_{Rd}	kN	NA	4.3	7.8*	15.3*	17.2*	25.4*	28.2*	37.5	51.9*
Cracked concrete											
Tensile	N_{Rd}	kN	NA	2.0	3.0	4.3	8.0	5.0	12.7	5.7	20.0
Shear	V_{Rd}	kN	NA	4.3	6.3	15.3*	17.2*	19.1	28.2*	26.2	51.9*

*Failure mode = steel; **Pending

Design resistances: JC6-KB range

			JC6 KB 6 A4	JC6 KB 8 A4	JC6 KB 10 A4	JC6 KB 12 A4
			PART 6	PART 6	OPTION 1	OPTION 1
Effective anchorage depth	h_{ef}	mm	43.1	22.2	58.7	75.6
Nominal anchorage depth	h_{nom}	mm	70.0	52.0	100.0	120.0
Non-cracked concrete						
Tensile	N_{Rd}	kN	3.3	1.3	10.7	13.9
Shear	V_{Rd}	kN	7.2*	3.4	14.7	31.2*
Cracked concrete						
Tensile	N_{Rd}	kN	3.3	1.3	4.7	6.7
Shear	V_{Rd}	kN	6.5	2.4	10.3	30.2

*Failure mode = steel

Recommended loads: JC2 range

			JC2 6: KB / FR / IT / ST			JC2 Plus 8		JC2 Plus 10		JC2 Plus 14	
			PART 6**	PART 6	OPTION 1	OPTION 1	OPTION 1	OPTION 1	OPTION 1	OPTION 1	OPTION 1
Effective anchorage depth	h_{ef}	mm	27.6	31.9	42.5	39.2	51.9	42.5	68.0	49.3	91.8
Nominal anchorage depth	h_{nom}	mm	35	40	55	50	65	55	85	65	115
Non-cracked concrete											
Tensile	N_{Rec}	kN	NA	1.4	4.5	5.7	8.8	6.5	13.1	7.1	20.0
Shear	V_{Rec}	kN	NA	3.1	5.6*	10.9*	12.3*	18.2*	20.1*	26.8	37.1*
Cracked concrete											
Tensile	N_{Rec}	kN	NA	1.4	2.1	3.1	5.7	3.6	9.0	4.0	14.3
Shear	V_{Rec}	kN	NA	3.1	4.5	10.9*	12.3*	13.6	20.1*	18.7	37.1*

*Failure mode = steel; **Pending

Recommended loads: JC6-KB range

			JC6 KB 6 A4	JC6 KB 8 A4	JC6 KB 10 A4	JC6 KB 12 A4
			PART 6	PART 6	OPTION 1	OPTION 1
Effective anchorage depth	h_{ef}	mm	43.1	22.2	58.7	75.6
Nominal anchorage depth	h_{nom}	mm	70.0	52.0	100.0	120.0
Non-cracked concrete						
Tensile	N_{Rec}	kN	2.4	1.0	7.6	9.9
Shear	V_{Rec}	kN	5.1*	2.5	10.5	22.3*
Cracked concrete						
Tensile	N_{Rec}	kN	2.4	1.0	3.3	4.8
Shear	V_{Rec}	kN	4.6	1.7	7.4	21.6

*Failure mode = steel

The data within these tables are based on:

Concrete C20/25, $f_{ck,cube} = 25N/mm^2$

Installation has been done correctly

No influence of edge distances and spacings

Minimum base material thickness is met

Precast pre-stressed hollow core slabs: Basic loading data (JC2 range only)

Characteristic resistances

JC2 6: KB / FR / IT / ST				
Nominal anchorage depth	h_{nom}	mm	40	
Flange thickness	d_b	mm	25	30 40
Loading for all directions	F_{Rk}	kN	1.0	2.0 3.0
Characteristic bending resistance	$M_{Rk,s}^0$	Nm	16.0	
Edge distance	$c_{cr} = c_{min}$	mm	100	
Spacing	$s_{cr} = s_{min}$	mm	100	

Design resistances

JC2 6: KB / FR / IT / ST				
Nominal anchorage depth	h_{nom}	mm	40	
Flange thickness	d_b	mm	25	30 40
Loading for all directions	F_{Rd}	kN	0.7	1.3 2.0
Characteristic bending resistance	$M_{Rd,s}$	Nm	12.8	
Edge distance	$c_{cr} = c_{min}$	mm	100	
Spacing	$s_{cr} = s_{min}$	mm	100	

Recommended loads

JC2 6: KB / FR / IT / ST				
Nominal anchorage depth	h_{nom}	mm	40	
Flange thickness	d_b	mm	25	30 40
Loading for all directions	F_{Rec}	kN	0.5	1.0 1.4
Characteristic bending resistance	M_{Rec}	Nm	9.1	
Edge distance	$c_{cr} = c_{min}$	mm	100	
Spacing	$s_{cr} = s_{min}$	mm	100	

The partial safety factor for action is $\gamma = 1.4$

Requirements for multiple anchoring

The definition of multiple use according to the Member States is given in annex of the ETAG 001 (Part 6)

Minimum numbers of fixing points	Minimum numbers of anchors per fixing points	Maximum design loads of action N_{sd}
3	1	2kN
4	1	3kN

The value N_{sd} might be increased if in the design it is shown that the requirements on the strength and stiffness of the fixture in the serviceability and ultimate states after the failure of one anchor are fulfilled.

The data within these tables are based on:

ETA-18/0221

Concrete C30/37 to C50/60

Installation has been done correctly

Edge distances and spacings

Setting instructions (JC2 range only)

Installation instructions in pre-stressed hollow core slabs

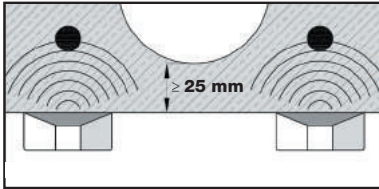

1. Locate rebars by means of suitable detector.

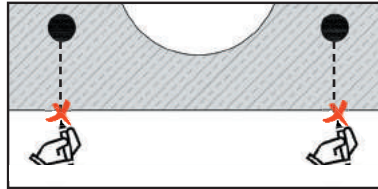

2. Mark rebar location.

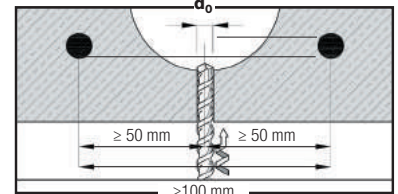

3. Make a cylindrical hole.

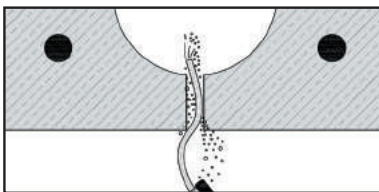

4. Clean the hole.

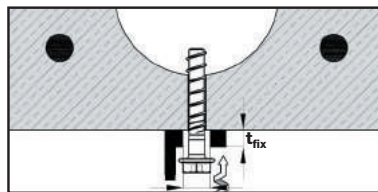

5. Install the screw anchor very gently by screw-driver or torque wrench. Avoid overtightening.

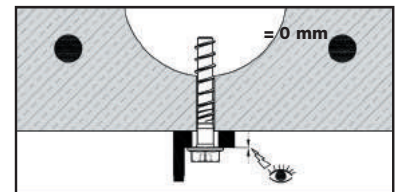

6. Ensure that the screw anchor head fully rests without any gap on the fixture and is not damaged.

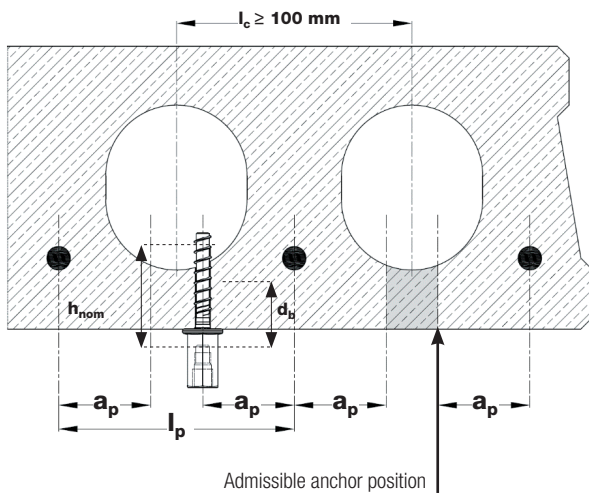

Admissible anchor position in pre-stressed hollow core slabs

Core distance	$l_c \geq 100 \text{ mm}$
Pre-stressing steel distance	$l_p \geq 100 \text{ mm}$
Distance between anchor position and prestressing steel	$a_p \geq 50 \text{ mm}$

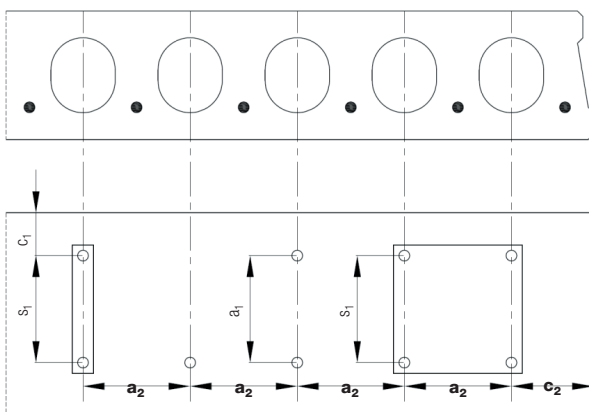

Minimum spacing and edge distance of anchors and distance between anchor groups in pre-stressed hollow core slabs

c1, c2	edge distance
s1, s2	anchor spacing
a1, a2	distance between anchor groups

Fire resistance



Design under fire exposure is performed according to the design method given in EOTA TR 020. The data within these tables are based on ETA-17/0835, ETA-18/0221 and ETA-21/0020.

Characteristic resistances: JC2 range

			JC2 6: KB / FR / IT / ST			JC2 Plus 8		JC2 Plus 10		JC2 Plus 14	
			PART 6**	PART 6	OPTION 1	OPTION 1	OPTION 1	OPTION 1	OPTION 1	OPTION 1	OPTION 1
Effective anchorage depth	h_{ef}	mm	27.6	31.9	42.5	39.2	51.9	42.5	68.0	49.3	91.8
Nominal anchorage depth	h_{nom}	mm	35	40	55	50	65	55	85	65	115
Fire Exposure R30											
Tensile	$N_{Rk, s, fi}$	kN	NA	0.24	0.24	0.42	0.42	0.99	0.99	2.13	2.65
Shear (steel failure)	$V_{Rk, s, fi}$	kN	NA	0.24	0.24	0.42	0.42	0.99	0.99	2.65	2.65
Fire exposure R60											
Tensile	$N_{Rk, s, fi}$	kN	NA	0.22	0.22	0.38	0.38	0.85	0.85	1.99	1.99
Shear (steel failure)	$V_{Rk, s, fi}$	kN	NA	0.22	0.22	0.38	0.38	0.85	0.85	1.99	1.99
Fire exposure R90											
Tensile	$N_{Rk, s, fi}$	kN	NA	0.17	0.17	0.30	0.30	0.66	0.66	1.73	1.73
Shear (steel failure)	$V_{Rk, s, fi}$	kN	NA	0.17	0.17	0.30	0.30	0.66	0.66	1.73	1.73
Fire exposure R120											
Tensile	$N_{Rk, s, fi}$	kN	NA	0.12	0.12	0.21	0.21	0.53	0.53	1.33	1.33
Shear (steel failure)	$V_{Rk, s, fi}$	kN	NA	0.12	0.12	0.21	0.21	0.53	0.53	1.33	1.33

The recommended loads under fire exposure include a safety factor for resistance under fire exposure $\gamma_{M,fi} = 1.0$ and the partial safety factor for action $\gamma_{F,fi} = 1.0$. The partial safety factors for action shall be taken from national regulations. **Pending

Characteristic resistances: JC6-KB range

			JC6 KB 6 A4	JC6 KB 8 A4	JC6 KB 10 A4	JC6 KB 12 A4
			PART 6	PART 6	OPTION 1	OPTION 1
Effective anchorage depth	h_{ef}	mm	43.1	22.2	58.7	75.6
Nominal anchorage Depth	h_{nom}	mm	70	52	100	120
Fire Exposure R30						
Tensile	$N_{Rk, s, fi}$	kN	0.23	0.40	1.70	2.90
Shear (steel failure)	$V_{Rk, s, fi}$	kN	0.23	0.40	1.70	2.90
Fire Exposure R60						
Tensile	$N_{Rk, s, fi}$	kN	0.20	0.40	1.30	2.40
Shear (steel failure)	$V_{Rk, s, fi}$	kN	0.20	0.40	1.30	2.40
Fire Exposure R90						
Tensile	$N_{Rk, s, fi}$	kN	0.16	0.40	1.00	2.00
Shear (steel failure)	$V_{Rk, s, fi}$	kN	0.16	0.40	1.00	2.00
Fire Exposure R120						
Tensile	$N_{Rk, s, fi}$	kN	0.11	0.30	0.90	1.60
Shear (steel failure)	$V_{Rk, s, fi}$	kN	0.11	0.30	0.90	1.60

The recommended loads under fire exposure include a safety factor for resistance under fire exposure $\gamma_{M,fi} = 1.0$ and the partial safety factor for action $\gamma_{F,fi} = 1.0$. The partial safety factors for action shall be taken from national regulations.

The data within these tables are based on:

Concrete C20/25, $f_{ck,cube} = 25 \text{ N/mm}^2$

Installation has been done correctly

No influence of edge distances and spacings

Minimum base material thickness is met

Material and dimensions

Material quality and coating

JC2 6: KB / FR / IT / ST	
Material	Cold forged carbon steel
Coating ZP	Zinc electroplated according to EN ISO 4042 $\geq 5 \mu\text{m}$
Coating ZA	Zinc alloy coating $\geq 8 \mu\text{m}$

JC6-KB	
Material	A4 stainless steel
Grade	316 austenitic
Lead Threads	Hardened carbon steel

Mechanical properties: JC2 range

			JC2 6: KB / FR / IT / ST			JC2 Plus 8		JC2 Plus 10		JC2 Plus 14	
			PART 6**	PART 6	OPTION 1	OPTION 1	OPTION 1	OPTION 1	OPTION 1	OPTION 1	
Effective anchorage depth	h_{ef}	mm	27.60	31.90	42.50	39.20	51.90	42.50	68.00	49.30	91.80
Nominal anchorage depth	h_{nom}	mm	35.00	40.00	55.00	50.00	65.00	55.00	85.00	65.00	115.00
Nominal tensile strength	F_{uk}	N/mm ²	800.00	800.00	800.00	800.00	800.00	800.00	800.00	800.00	800.00
Characteristic bending resistance	$M_{Rk,s}^0$	Nm	16.00			37.00	45.00	72.00	84.00	207.00	227.00
Nominal diameter	d_{nom}	mm	6.00			8.00		10.00		14.00	
Thread outer diameter	d_{th}	mm	7.45			10.50		12.70		16.55	
Shaft diameter	d_s	mm	5.88			7.80		9.62		13.40	
Diameter of integrated washer (KB)	D	mm	16.50			17.50		20.50		28/29.50	
Diameter of integrated washer (IT)	D	mm	14.20/17.00			-		-		-	
Diameter of pan head (FR)	D	mm	14.50			-		-		-	
Diameter of countersunk (ST)	D	mm	14.00			-		-		-	

Mechanical properties: JC6-KB range

			JC6 KB 6 A4	JC6 KB 8 A4	JC6 KB 10 A4	JC6 KB 12 A4
			PART 6	PART 6	OPTION 1	OPTION 1
Effective anchorage depth	h_{ef}	mm	43.1	22.2	58.7	75.6
Nominal anchorage depth	h_{nom}	mm	70.0	52.0	100.0	120.0
Nominal tensile strength	F_{uk}	N/mm ²	800.0	800.0	800.0	800.0
Characteristic bending resistance	$M_{Rk,s}^0$	Nm	14.6	35.9	74.4	130.6
Nominal diameter	d_{nom}	mm	6.0	8.0	10.0	12.0
Thread outer diameter	d_{th}	mm	7.5	9.9	12.5	14.3
Shaft diameter	d_s	mm	5.5	7.4	9.4	11.3
Diameter of integrated washer (KB)	D	mm	13.0	20.0	22.0	25.0

Installation instructions

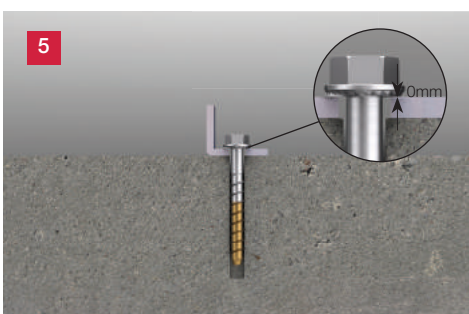
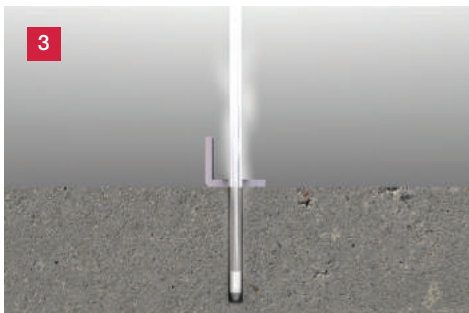
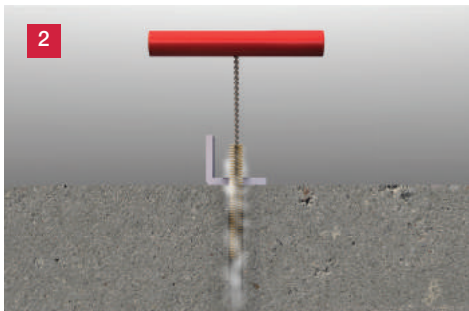

Notes

Concrete and hollow core slab

Concrete strength is C20/25 to C50/60. Hollow core slabs C30/37 to C50/60.

No significant voids in concrete.

Concrete is well compacted.

Thickness of concrete is according PDS installation data.

Installation

Edge distances and spacing are according PDS installation data.

Use proper air pump or compressor.

Drill hole is deep enough (mentioned h_1 in PDS installation data).

All dust should be cleaned from the hole to avoid screw seizing during installation.

Pay special attention to cleaning, especially when installing downwards.

In case of aborted hole, drilling of new hole at a minimum distance of twice the depth of the aborted hole, or smaller distance provided the aborted drill hole is filled with high strength non-shrinkage mortar. No shear or oblique tension loads are allowed in the direction of a not filled aborted hole.

Other base materials

Concrete screws can also be used in other base materials such as solid clay brick and solid sand-lime brick.

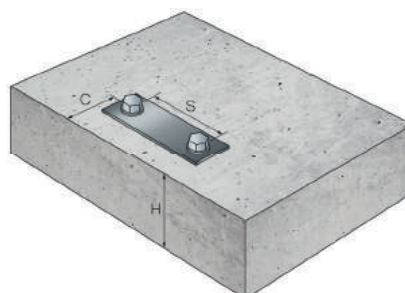
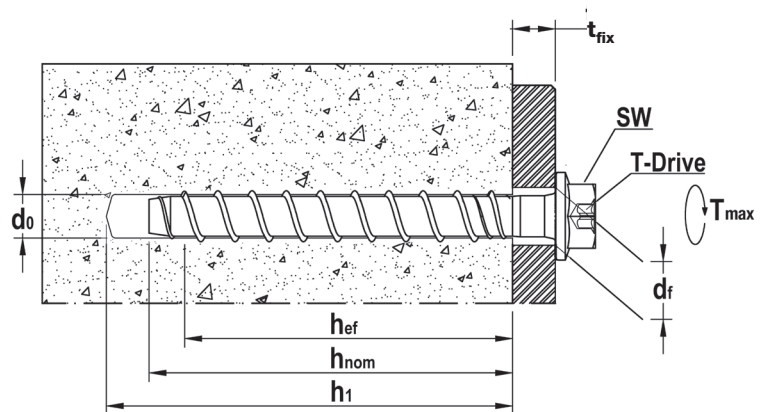

Installation parameters

Minimum thickness of concrete member, spacing and edge distance: JC2 range

			JC2 6: KB / FR / IT / ST			JC2 Plus 8		JC2 Plus 10		JC2 Plus 14	
			PART 6**	PART 6	OPTION 1	OPTION 1	OPTION 1	OPTION 1	OPTION 1	OPTION 1	OPTION 1
Effective anchorage depth	h_{ef}	mm	27.6	31.9	42.5	39.2	51.9	42.5	68	49.3	91.8
Nominal anchorage depth	h_{nom}	mm	35	40	55	50	65	55	85	65	115
Minimum thickness of base materials	h_{min}	mm	80	100	100	100	115	100	130	120	150
Minimum spacing	s_{min}	mm	35	35	35	35	35	40	40	60	60
Minimum edge distance	c_{min}	mm	30	35	35	35	35	40	40	60	60
Characteristic edge distance concrete cone failure	$c_{cr,N}$	mm	41	48	64	59	78	64	102	74	138
Characteristic spacing concrete cone failure	$s_{cr,N}$	mm	83	96	128	128	156	128	204	148	275
Characteristic edge distance for splitting failure	$c_{cr,sp}$	mm	55	48	64	59	88	64	116	74	139
Characteristic spacing for splitting failure	$s_{cr,sp}$	mm	110	96	128	118	176	128	232	148	275
Diameter of drill bit	d_0	mm	6	6	6	8	8	10	10	14	14
Depth of drilled hole	$h_1 \geq$	mm	40	50	65	60	75	65	95	75	125
Diameter of clearance hole in fixture	d_f	mm	9.0			10.8 - 12.0		13.0 - 14.0		17.0 - 18.0	
Max. torque, impact driver	T_{SD}	Nm	90			290		650		650	
Max. torque, manual	$T_{inst} \leq$	Nm	14			45		85		100	

**Pending

Minimum thickness of concrete member, spacing and edge distance: JC6-KB range

			JC6 KB 6 A4		JC6 KB 8 A4		JC6 KB 10 A4		JC6 KB 12 A4	
			PART 6	PART 6	OPTION 1	OPTION 1	OPTION 1	OPTION 1		
Effective anchorage depth	h_{ef}	mm	43.1		22.2		58.7		75.6	
Nominal anchorage depth	h_{nom}	mm	70		52		100		120	
Minimum thickness of base material	h_{min}	mm	110		100		140		170	
Minimum spacing	s_{min}	mm	40		55		60		70	
Minimum edge distance	c_{min}	mm	40		55		60		70	
Characteristic edge distance concrete cone failure	$c_{cr,N}$	mm	$1.5h_{ef}$		$1.5h_{ef}$		$1.5h_{ef}$		$1.5h_{ef}$	
Characteristic spacing concrete cone failure	$s_{cr,N}$	mm	$3.0h_{ef}$		$3.0h_{ef}$		$3.0h_{ef}$		$3.0h_{ef}$	
Characteristic edge distance for splitting failure	$c_{cr,sp}$	mm	$1.5h_{ef}$		$1.5h_{ef}$		$1.5h_{ef}$		$1.5h_{ef}$	
Characteristic spacing for splitting failure	$s_{cr,sp}$	mm	$3.0h_{ef}$		$3.0h_{ef}$		$3.0h_{ef}$		$3.0h_{ef}$	
Diameter of drill bit	d_0	mm	6		8		10		12	
Minimum hole depth in concrete	$h_1 \geq$	mm	80		65		110		130	
Diameter of clearance hole in fixture	d_f	mm	9		11		13		15	
Max. torque, impact driver	$T_{max} \leq$	Nm	120		185		185		185	
Width across the flats	SW	mm	10		13		17		19	

Installation tools and accessories

Drills and drilling systems

SDS drill bits: 6 - 14mm diameter



EJOT vortex-SDS

Dust removal at source for drilling dense concrete, brick and block

Modular drilling components with unique carbide tips. The four-cutter design creates a more precise drill hole whilst dust is extracted through the system.



EJOT vortex-SDS **Standard drill bits 8 - 14mm**



EJOT vortex-SDS **Modular system 16 - 20mm**



For further information visit EJOT online or contact our technical team.
Call 01977 687040
info@ejot.co.uk

Cleaning

Cleaning brushes

Hole diameter range: 10 - 28mm

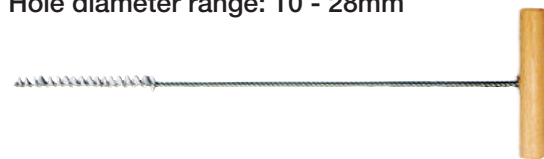

Blow-out pump

400ml



Driver and wrench

Impact Wrench

FEIN cordless ASCD
18-300 W2 Select

Specifically for use with EJOT's JC2 and JC6-KB concrete screws up to M18



Torque Wrench

½" - 10 - 50 Nm

Release accuracy ± 3% according to DIN EN ISO 6789-1: 2017-07



Sockets and adaptor

Short impact socket

¼" drive

For hex head: SW10, SW13, SW15, SW17, SW19, SW21, SW24

For concrete screws: JC2-KB Plus, JC2-KB, JCT-IT and JC6-KB



Impact socket

T30 ½" drive

For concrete screws: JC2-ST6, JC2-FR6



Square drive adaptor

¼" to ½"

Used when installing with an impact driver and where changing from impact driver to torque wrench





Calculation software

EJOT's Anchor-fix dimensioning software is a 'go-to' tool to assist designers with pre-planning through to static requirements for critical building projects.

The program was developed for structural engineers, specifiers, engineers and technicians to calculate the load-carrying capacity of anchor bolts in concrete substrates - allowing data to be archived for reference.

Download here:

www.ejot.com/software-anchorfix



On site testing and support

When specifying outside of any standard technical parameters our technical team will recommend an on-site test report, carried out by a qualified EJOT engineer.

No-one can second guess the integrity of substrates. We want our customers to have absolute peace of mind and confidence in the match between fixing and substrate - and the correct installation process.



ETA Approved through-bolts

EJOT through-bolts provide Option 1 and Option 7 product solutions for performance-driven designers and installers.

Ask for our brochure or visit www.ejot.co.uk/throughbolts



EJOT U.K. Limited,
Hurricane Close,
Sherburn Enterprise Park,
Sherburn-in-Elmet,
Leeds LS25 6PB.
United Kingdom

Tel: +44 1977 68 70 40
Fax: +44 1977 68 70 41
Email: info@ejot.co.uk

EJOT® The Quality Connection